



NB605/0705-03XX

接线端子-插座

额定电流: 15 A

额定电压: 300 V

间距: 7.5 mm/7.62mm

极数: 2P~24P

28-12AWG

尺寸图
Dimensions

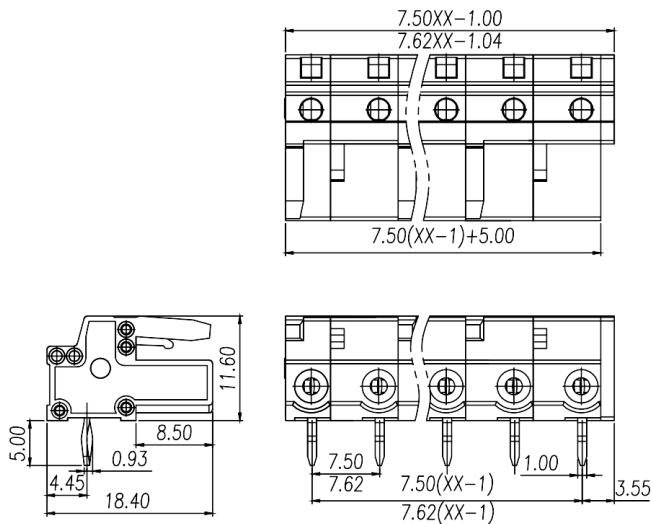

PCB开孔图
PCB Opening diagram

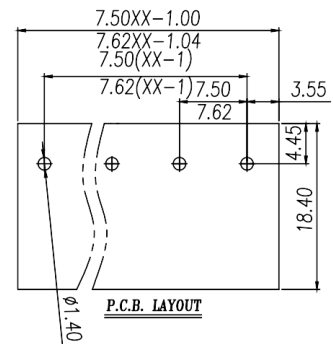

仅供参考，实际规格依产品工程图为准 版本2.0



技术数据-UL/CUL

等级 Use Group	B	C	D
额定电压 Rate Voltage	300V	-	300V
额定电流 Rated Current	15A	-	10A
接线范围 Wire Range		-	
耐电压 Dielectric Voltage-Withstand		1.6KV	

技术参数-IEC

过电压类别 Overvoltage Category	III	III	II
污染等级 Contamination Class	3	2	2
额定电压 Rated Voltage	320V	320V	630V
额定电流 Rated Current	12A	12A	12A
额定冲击电压 Impulse withstand voltage	4KV	4KV	4KV
导线截面积[硬/柔] Conductor cross section		/	

材料 Material

绝缘材料 Insulation Material	PA66
阻燃等级 Flame retardant rating	UL94V-0
导体材料 Conductor Material	Copper alloy
导体表面镀层 Plating of conductor surface	Sn plated

一般参数 Other Data

间距 Pitch	7.5 mm/7.62mm
----------	---------------

极数 Poles	2P~24P
剥线长度 Stripping Length	/
螺丝 Screw	/
扭矩 Torque	/
工作温度 Operating temperature	-40~+105
焊锡温度 Soldering temperature	260 /5S
引针尺寸 Pin dimensions	0.6*1.0mm
PCB板孔径 PCB Hole Diameter	Ø1.4mm

商业数据

产品型号	NB605/0705-03XX		
产品编号	-		
包装方式	内袋	内盒	外箱



宁波佳绩机电科技有限公司
佳绩电子科技（宁波）有限公司

地址：宁波市海曙区高桥镇新港路8号

邮编：315000

总机：+86 574-55665696

传真：+86 574-55842261

邮箱：shangwu@nbjiaji.com

Ningbo jiaji Electronics Co.,Ltd

Address: No. 8 Xingang Road, Gaoqiao Town,
Haishu District, Ningbo City, Zhejiang Province

Zip code: 315000

Switchboard: +86 574-55665696

Fax: +86 574-55842261

E-mail: shangwu@nbjiaji.com