

## NBT02

接线端子-插座

额定电流: 8A

额定电压: 150 V

间距: 3.5mm

极数: 2P~24P

安装: 回流焊

### 尺寸图 Dimensions

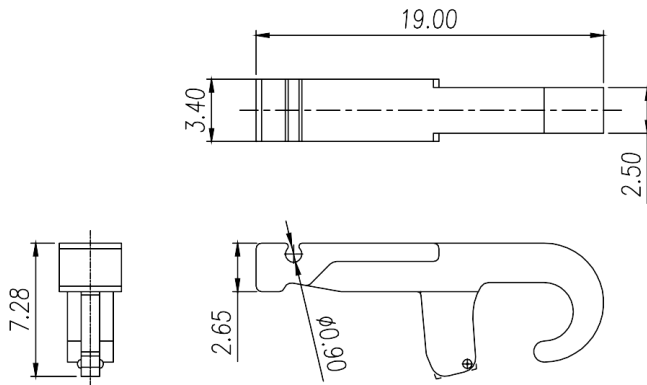

仅供参考，实际规格依产品工程图为准 版本2.0



技术数据-UL/CUL

等级 Use Group	B	C	D
额定电压 Rate Voltage	150V	-	-
额定电流 Rated Current	8A	/	-
接线范围 Wire Range		/	
耐电压 Dielectric Voltage-Withstand		1.3KV	
<b>技术参数-IEC</b>			
过电压类别 Overvoltage Category	III	III	II
污染等级 Contamination Class	3	2	2
额定电压 Rated Voltage	160V	200V	320V
额定电流 Rated Current	8A	8A	8A
额定冲击电压 Impulse withstand voltage	2.5KV	2.5KV	2.5KV
导线截面积[硬/柔] Conductor cross section		/	
<b>材料 Material</b>			
绝缘材料 Insulation Material		PA66	
阻燃等级 Flame relardant rating		UL94V-0	
导体材料 Conductor Material		Copper alloy	
导体表面镀层 Plating of conductor surface		Sn plated	
<b>一般参数 Other Data</b>			
间距 Pitch		3.5mm	
极数 Poles		2P~24P	

剥线长度 Stripping Length	/
螺丝 Screw	/
扭矩 Torque	/
工作温度 Operating temperature	-40~+105
焊锡温度 Soldering temperature	/
引针尺寸 Pin dimensions	/
PCB板孔径 PCB Hole Diameter	/

#### 商业数据

产品型号	NBT02		
产品编号	-		
包装方式	内袋	内盒	外箱



#### 宁波佳绩机电科技有限公司 佳绩电子科技（宁波）有限公司

地址：宁波市海曙区高桥镇新港路8号  
邮编：315000  
总机：+86 574-55665696  
传真：+86 574-55842261  
邮箱：shangwu@nbjiaji.com

Ningbo jiaji Electronics Co.,Ltd  
Address: No. 8 Xingang Road, Gaoqiao Town,  
Haishu District, Ningbo City, Zhejiang Province  
Zip code: 315000  
Switchboard: +86 574-55665696  
Fax: +86 574-55842261  
E-mail: shangwu@nbjiaji.com