

## NB2EDGL-5.0-XXP

接线端子-插座

额定电流: 15 A

额定电压: 300 V

间距: 5.0 mm

极数: 2P~24P

安装: 回流焊

尺寸图  
Dimensions

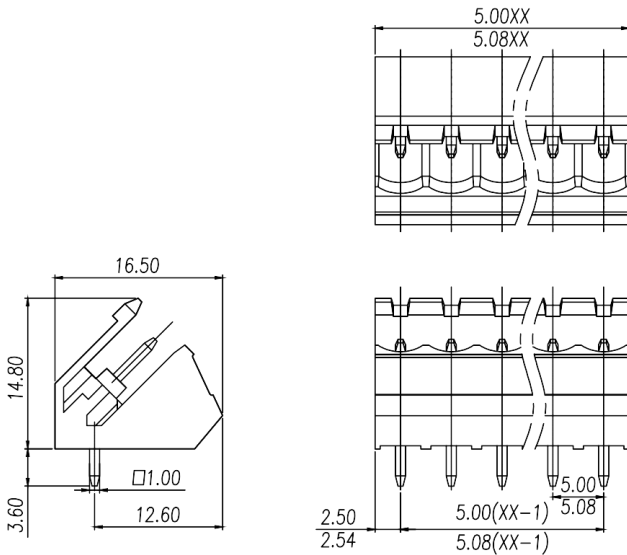

PCB开孔图  
PCB Opening diagram

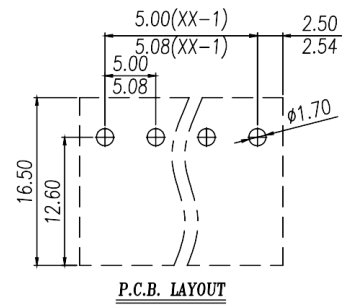

仅供参考, 实际规格依产品工程图为准 版本2.0



技术数据-UL/CUL

等级 Use Group	B	C	D
额定电压 Rate Voltage	300V	-	300v
额定电流 Rated Current	15A	-	10A
接线范围 Wire Range	/		
耐电压 Dielectric Voltage-Withstand	1.6KV		
<b>技术参数-IEC</b>			
过电压类别 Overvoltage Category	III	III	II
污染等级 Contamination Class	3	2	2
额定电压 Rated Voltage	250V	320V	400V
额定电流 Rated Current	12A	12A	12A
额定冲击电压 Impulse withstand voltage	4KV	4KV	4KV
导线截面积[硬/柔] Conductor cross section	/		
<b>材料 Material</b>			
绝缘材料 Insulation Material	PA66		
阻燃等级 Flame relardant rating	UL94V-0		
导体材料 Conductor Material	Copper alloy		
导体表面镀层 Plating of conductor surface	Sn plated		
<b>一般参数 Other Data</b>			
间距 Pitch	5.0mm		
极数 Poles	2P~24P		

剥线长度 Stripping Length	/
螺丝 Screw	/
扭矩 Torque	/
工作温度 Operating temperature	-40~+105
焊锡温度 Soldering temperature	260 /5S
引针尺寸 Pin dimensions	1.0*1.0mm
PCB板孔径 PCB Hole Diameter	Ø1.7mm

#### 商业数据

产品型号	NB2EDGL-5.0-XXP		
产品编号	-		
包装方式	内袋	内盒	外箱



#### 宁波佳绩机电科技有限公司 佳绩电子科技（宁波）有限公司

地址: 宁波市海曙区高桥镇新港路8号  
邮编: 315000  
总机: +86 574-55665696  
传真: +86 574-55842261  
邮箱: shangwu@nbjjaji.com

Ningbo jiaji Electronics Co.,Ltd  
Address: No. 8 Xingang Road, Gaoqiao Town,  
Haishu District, Ningbo City, Zhejiang Province  
Zip code: 315000  
Switchboard: +86 574-55665696  
Fax: +86 574-55842261  
E-mail: shangwu@nbjjaji.com