

NB48H-9.5-XXP

栅栏式接线端子

额定电流: 20 A

额定电压: 300 V

间距: 9.5 mm

使用线径: 22~12AWG

极数: 2P~22P

安装: 波峰焊

尺寸图

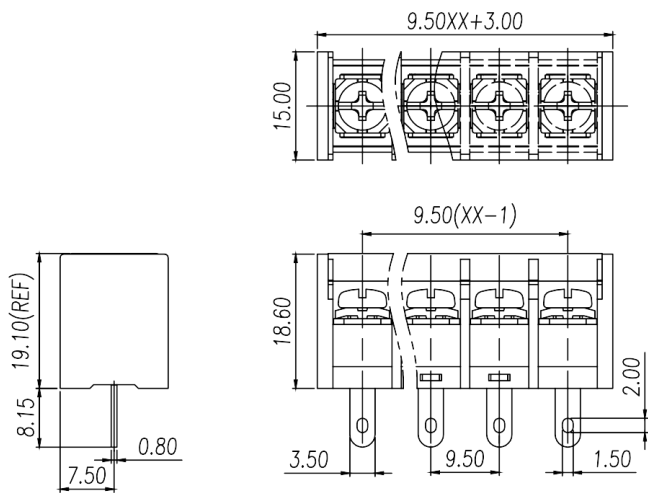

PCB开孔图

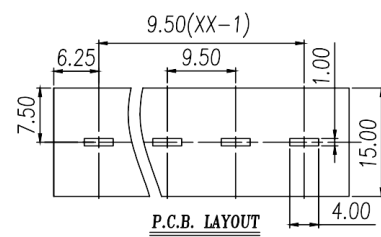

仅供参考，实际规格依产品工程图为准 版本2.0



材质及电镀 Material

螺丝 Screws M3.0 Steel Ni plated

焊脚 Pin Header Copper alloy , Sn plated

塑件 Housing PA66 , UL94V-0

电气性能 Electrical

参考标准 Standard UL IEC

额定电压 Rated voltage 300V 400V

额定电流 Rated current 20A 24A

使用线径 Wire range 22~12AWG 2.5mm²

接触电阻 Contact Resistance 20m

绝缘电阻 Insulation resistance 500M /DC500V

耐电压 Withstanding voltage AC2000V/1Min

一般参数 Other Data

间距 Pitch 9.5mm

极数 Poles 2P~22P

工作温度 Operating temperature -40 ~+105

扭矩 Torque 12.24kgf-cm/1.2Nm/10.6Lbin

商业数据

产品型号

NB48H-9.5-XXP

产品编号

-

包装方式

内袋

内盒

外箱



宁波佳绩机电科技有限公司
佳绩电子科技（宁波）有限公司

地址: 宁波市海曙区高桥镇新港路8号

邮编: 315000

总机: +86 574-55665696

传真: +86 574-55842261

邮箱: shangwu@nbjiaji.com

Ningbo jiaji Electronics Co.,Ltd

Address: No. 8 Xingang Road, Gaoqiao Town,

Haishu District, Ningbo City, Zhejiang Province

Zip code: 315000

Switchboard: +86 574-55665696

Fax: +86 574-55842261

E-mail: shangwu@nbjiaji.com