

NB129-7.5-XXP

螺钉式接线端子

额定电流: 20A

额定电压: 300 V

间距: 7.5 mm

使用线径: 26~12AWG

极数: 2P~24P

安装: 波峰焊

尺寸图

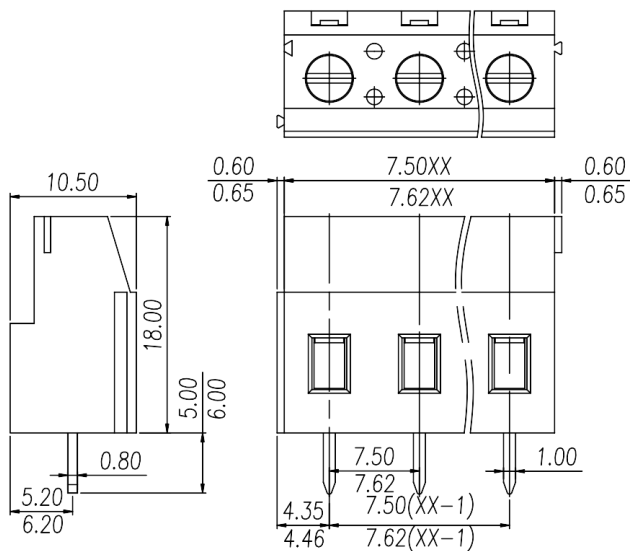

PCB开孔图

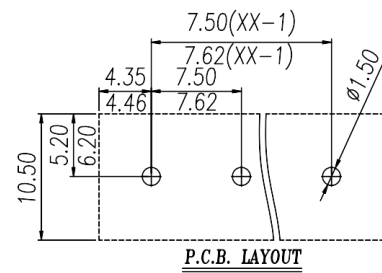

仅供参考，实际规格依产品工程图为准 版本2.0

技术数据-UL/CUL

等级 Use Group	B	C	D
额定电压 Rate Voltage	300V	-	300V
额定电流 Rated Current	20A	-	10A
接线范围 Wire Range	26~12AWG		
耐电压 Dielectric Voltage-Withstand	1.6KV		

技术参数-IEC

过电压类别 Overvoltage Category	III	III	II
污染等级 Contamination Class	3	2	2
额定电压 Rated Voltage	450V	630V	1000V
额定电流 Rated Current	24A	24A	24A
额定冲击电压 Impulse withstand voltage	6.0KV	6.0KV	6.0KV
导线截面积[硬/柔] Conductor cross section	0.5~2.5mm ²		

材料 Material

绝缘材料 Insulation Material	PA66
阻燃等级 Flame retardant rating	UL94V-0
导体材料 Conductor Material	Copper alloy
导体表面镀层 Plating of conductor surface	Sn plated

一般参数 Other Data

间距 Pitch	7.5 mm
----------	--------

极数 Poles	2P~24P
剥线长度 Stripping Length	6~7mm
螺丝 Screw	M3
扭矩 Torque	0.5N.m
工作温度 Operating temperature	-40~+105
焊锡温度 Soldering temperature	260 /5S
引针尺寸 Pin dimensions	0.8X1.0
PCB板孔径 PCB Hole Diameter	Ø1.5

商业数据

产品型号	NB129-7.5-XXP		
产品编号	-		
包装方式	内袋	内盒	外箱



宁波佳绩机电科技有限公司 佳绩电子科技（宁波）有限公司

地址: 宁波市海曙区高桥镇新港路8号
邮编: 315000
总机: +86 574-55665696
传真: +86 574-55842261
邮箱: shangwu@nbjjaji.com

Ningbo jiaji Electronics Co.,Ltd
Address: No. 8 Xingang Road, Gaoqiao Town,
Haishu District, Ningbo City, Zhejiang Province
Zip code: 315000
Switchboard: +86 574-55665696
Fax: +86 574-55842261
E-mail: shangwu@nbjjaji.com